

/ARCHSOURCING

EXPORTACIÓN

IMPORTACIÓN

“

Industry stakeholders expect to see more change in the built environment within the next 5 years than there has been in the last 50 years.

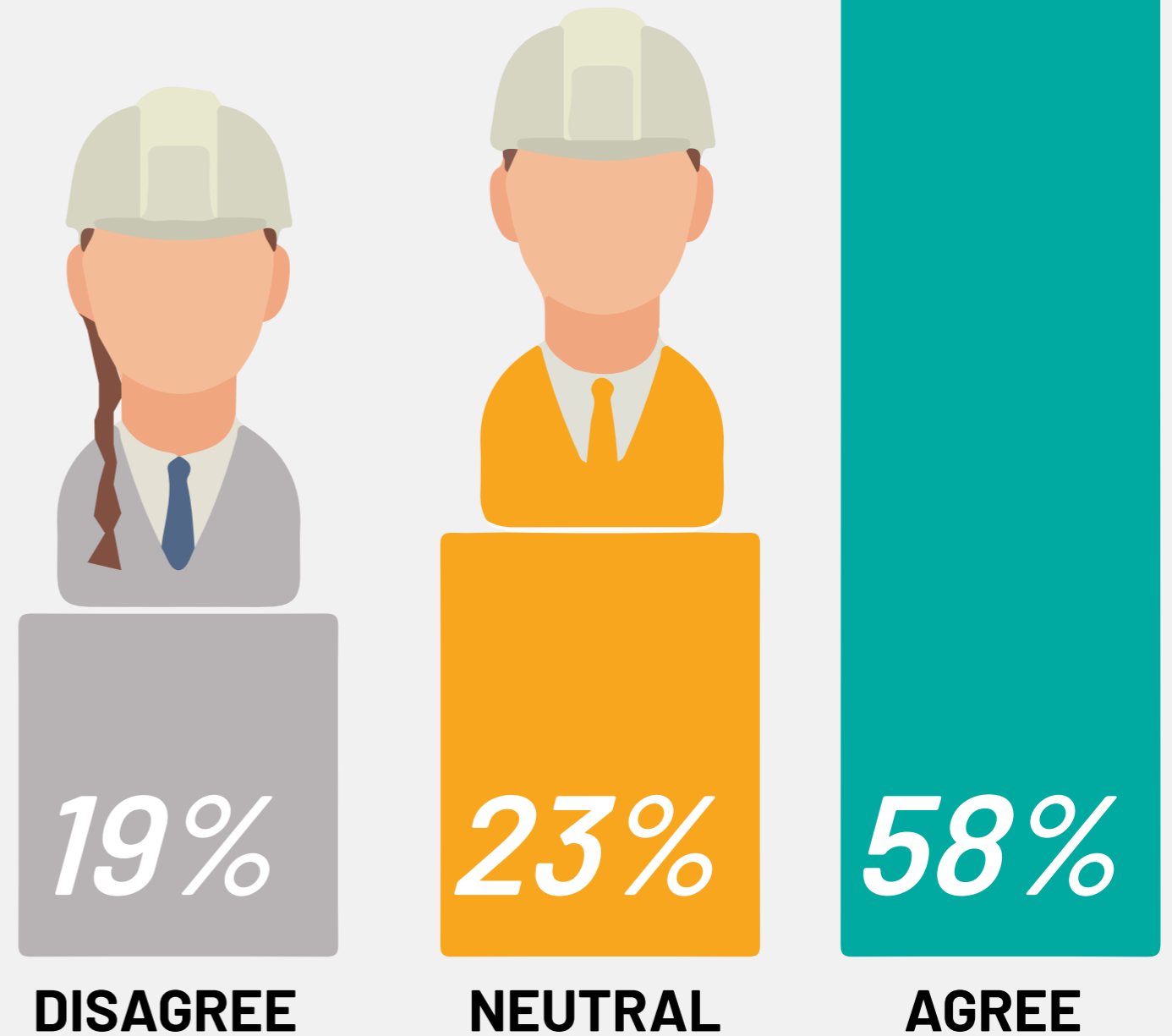

TALC

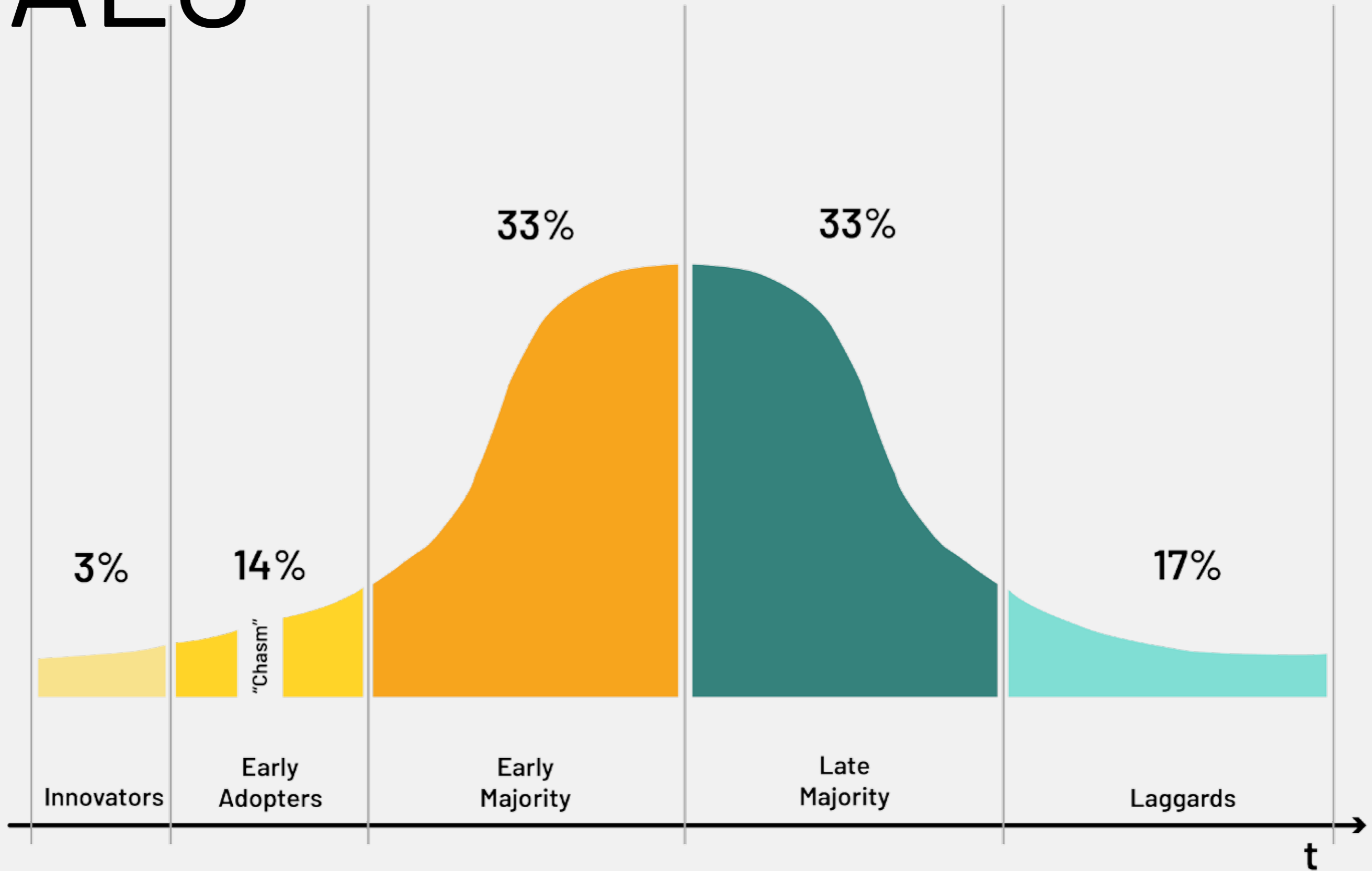



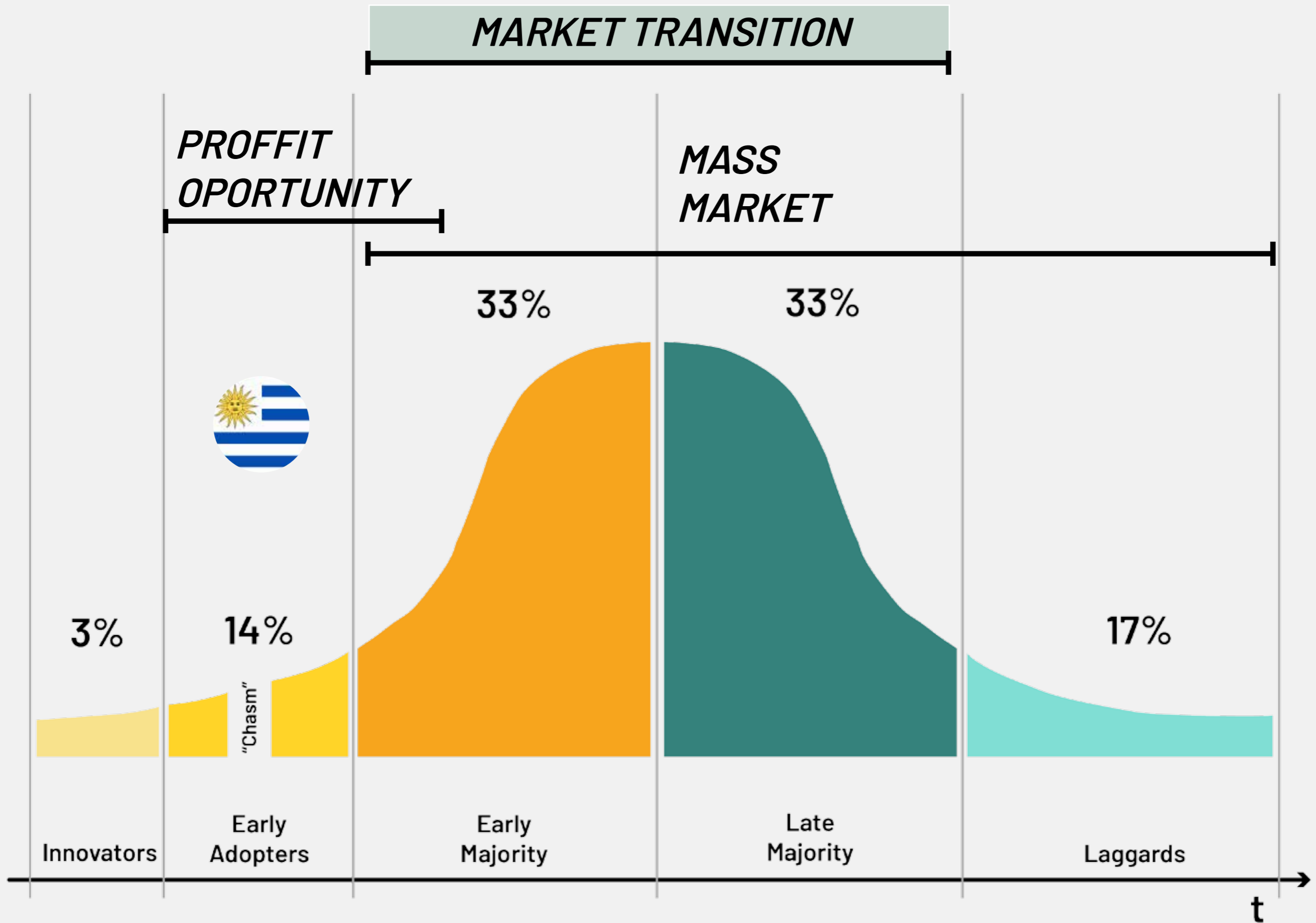

QR READER

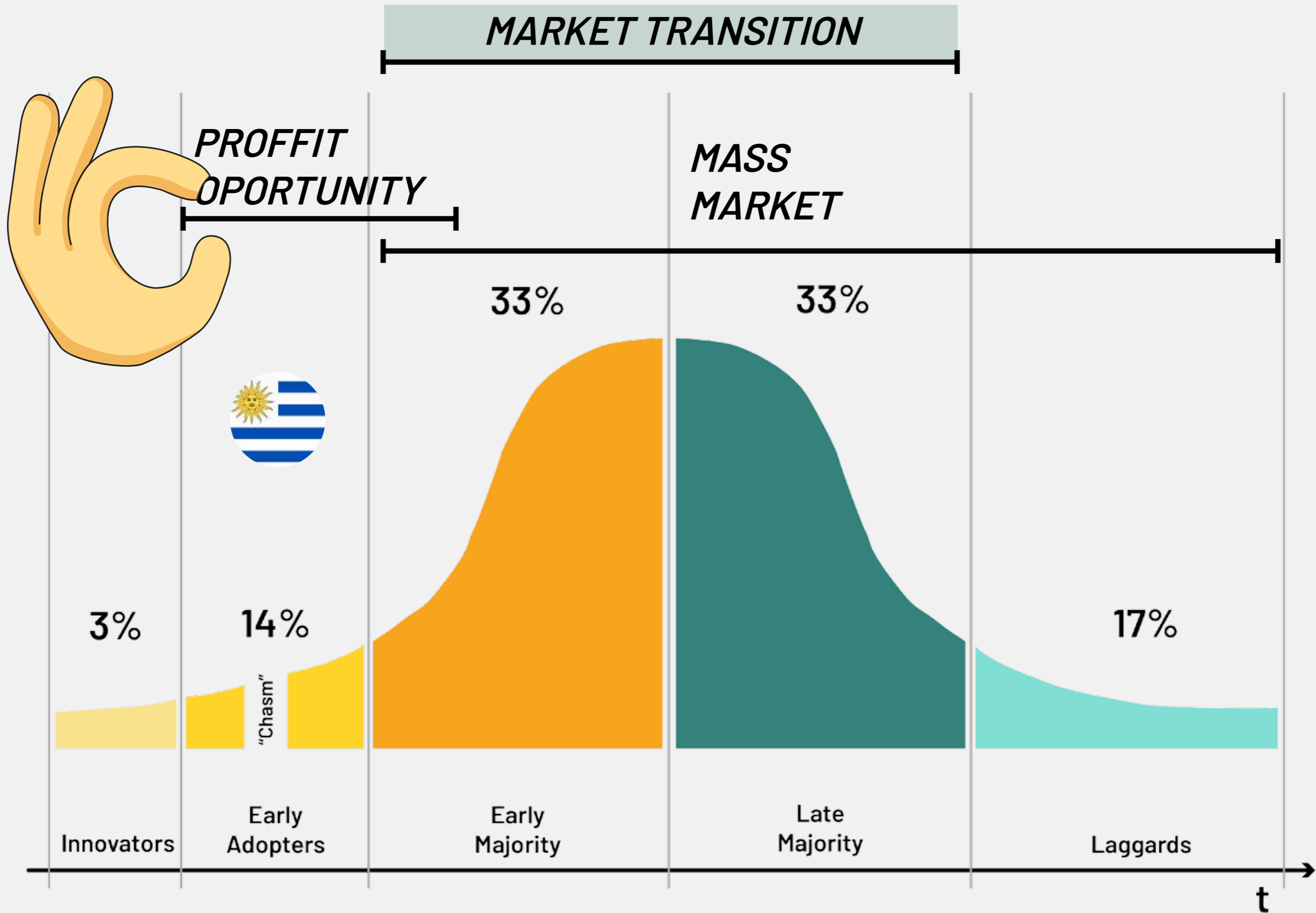

***Hola, quiero vender
BIM en Uruguay.***

HELP

...

“

Have the design documents provided to your firm been less complete and less coherent than in the past?

YES, Less Complete

NO



8%



HOW DO YOU EAT AN ELEPHANT?

One Bite at a Time

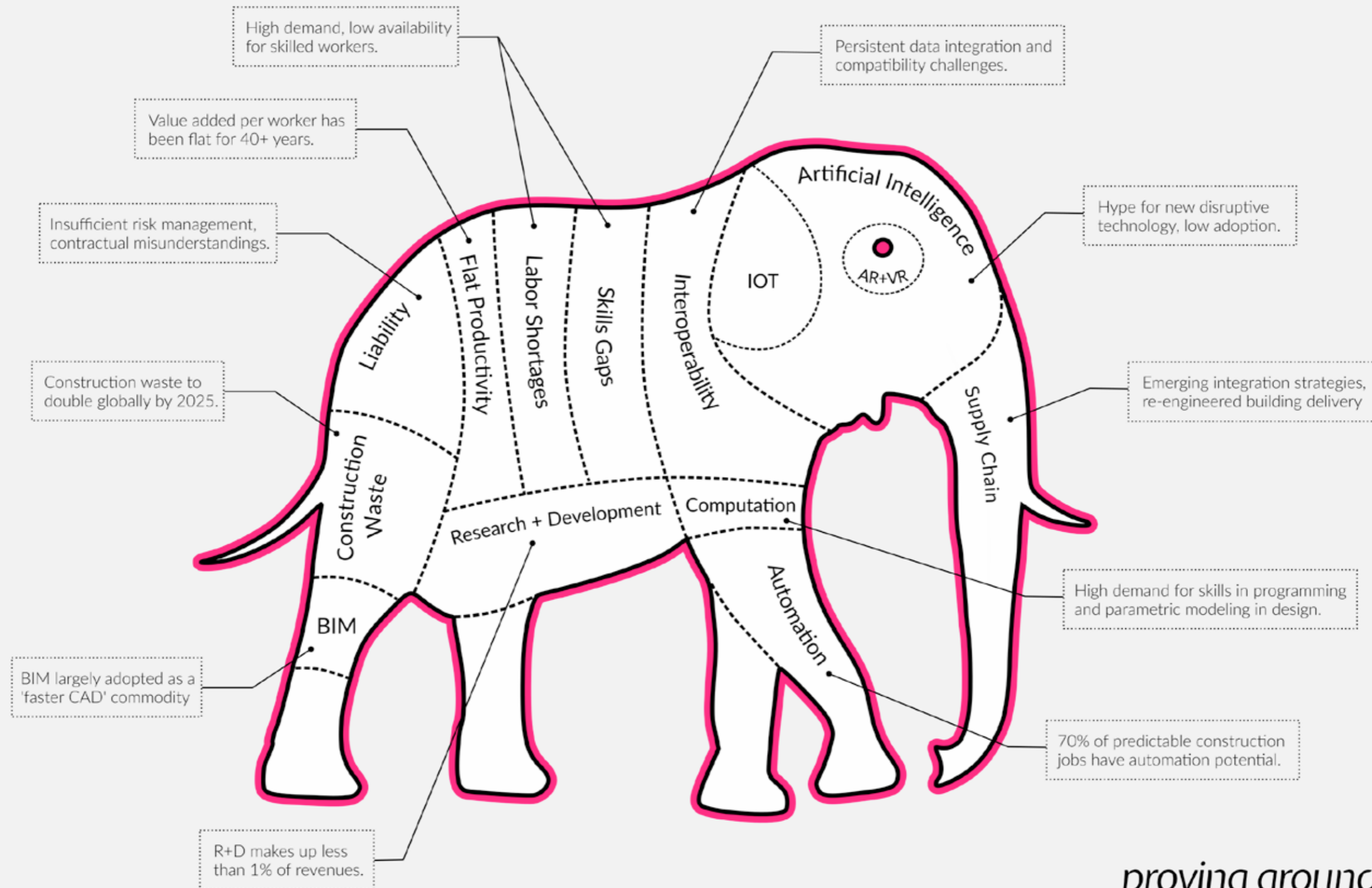

proving ground
<https://provingground.io>

high demand, low availability
for skilled workers

70% of predictable
construction jobs have
automation potential

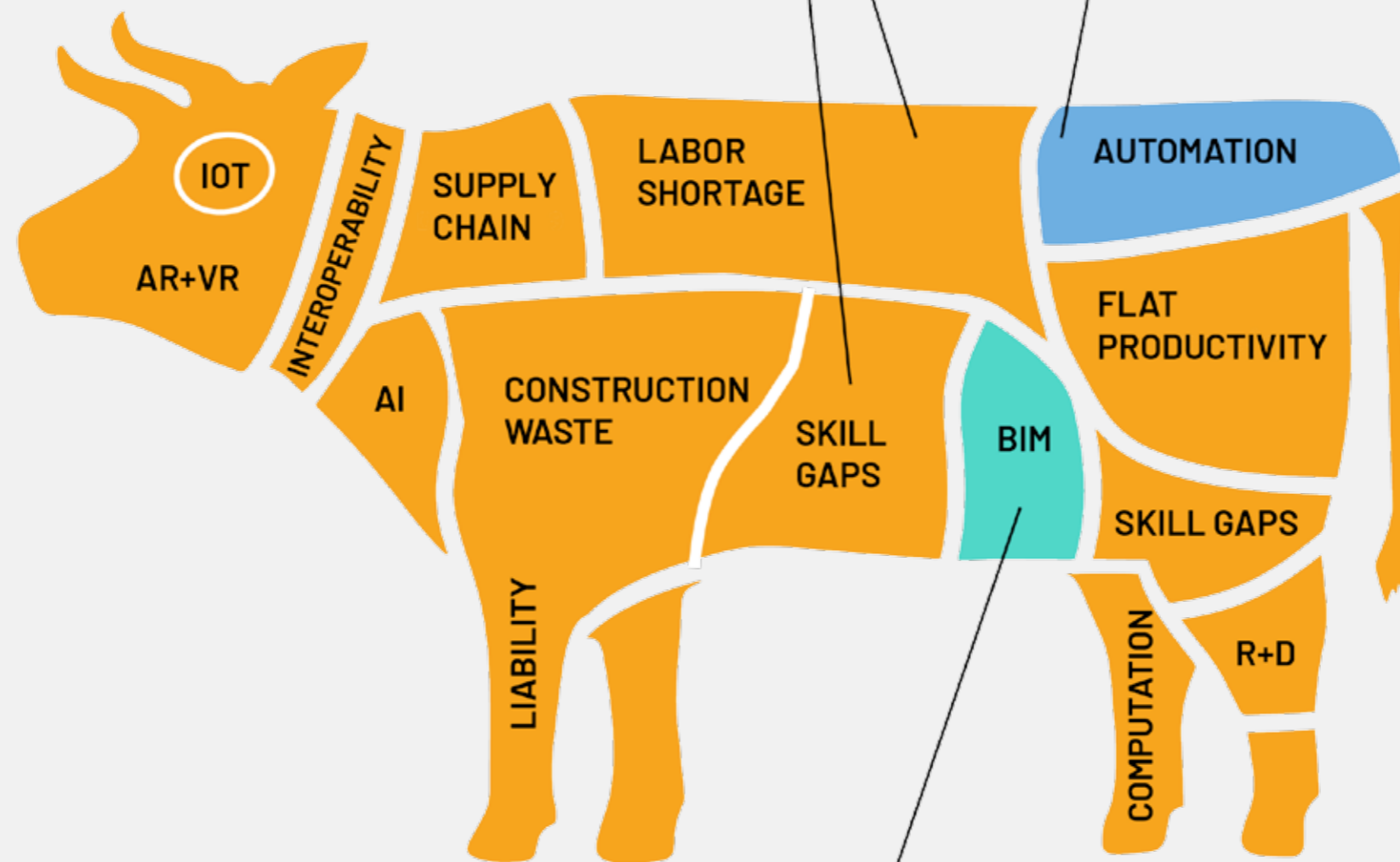

Largely adopted as
a "faster CAD"
comodity

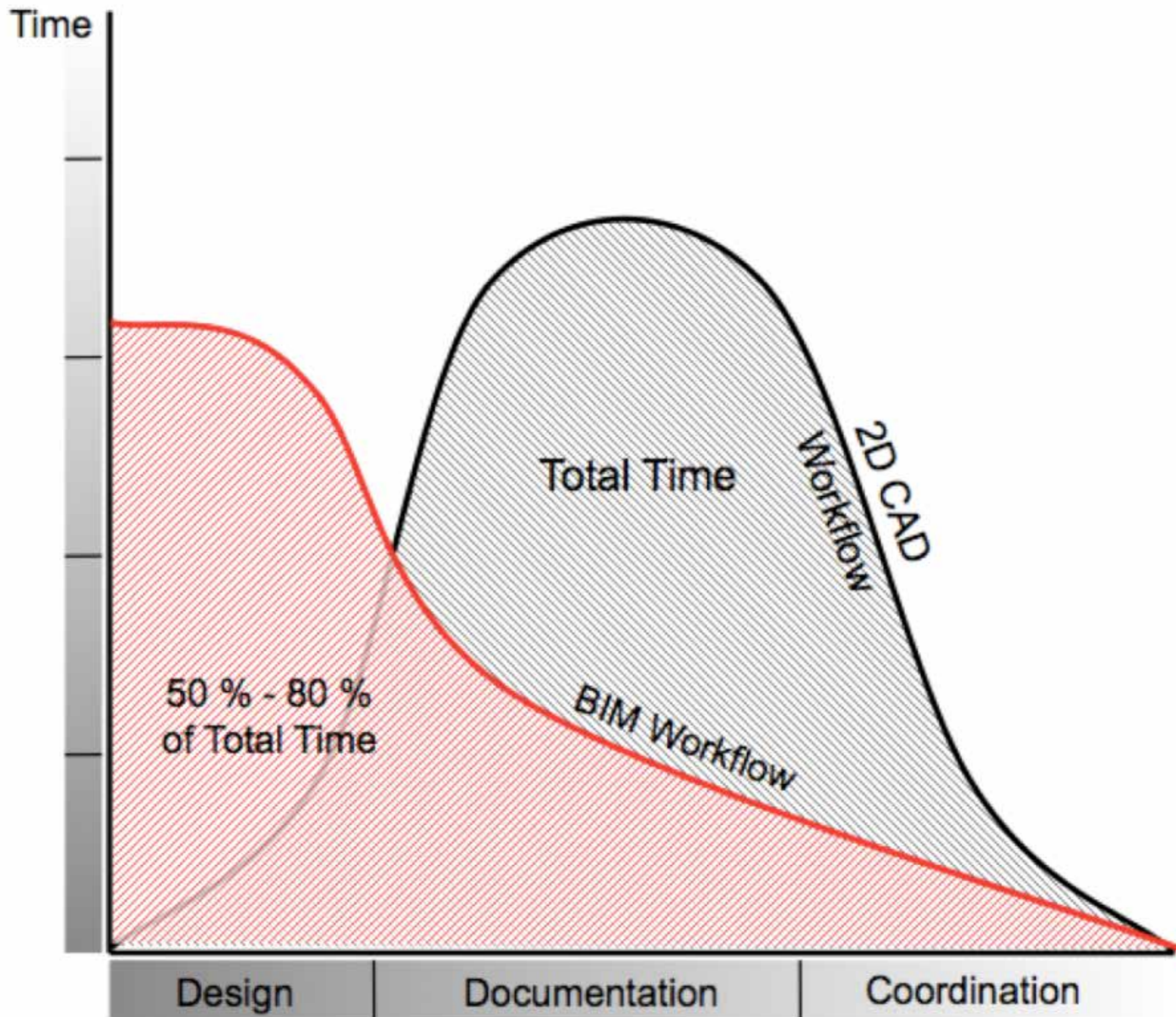

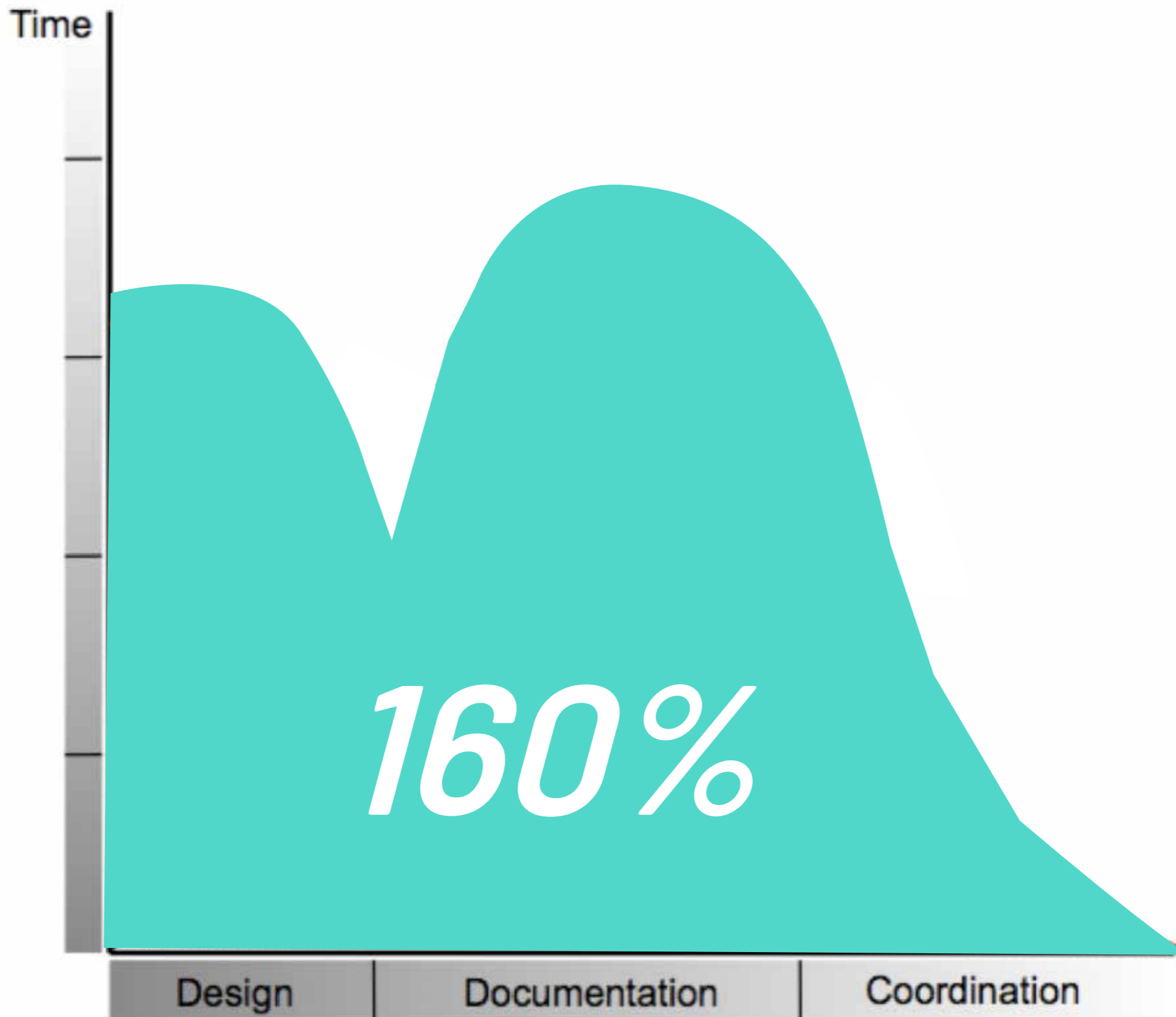

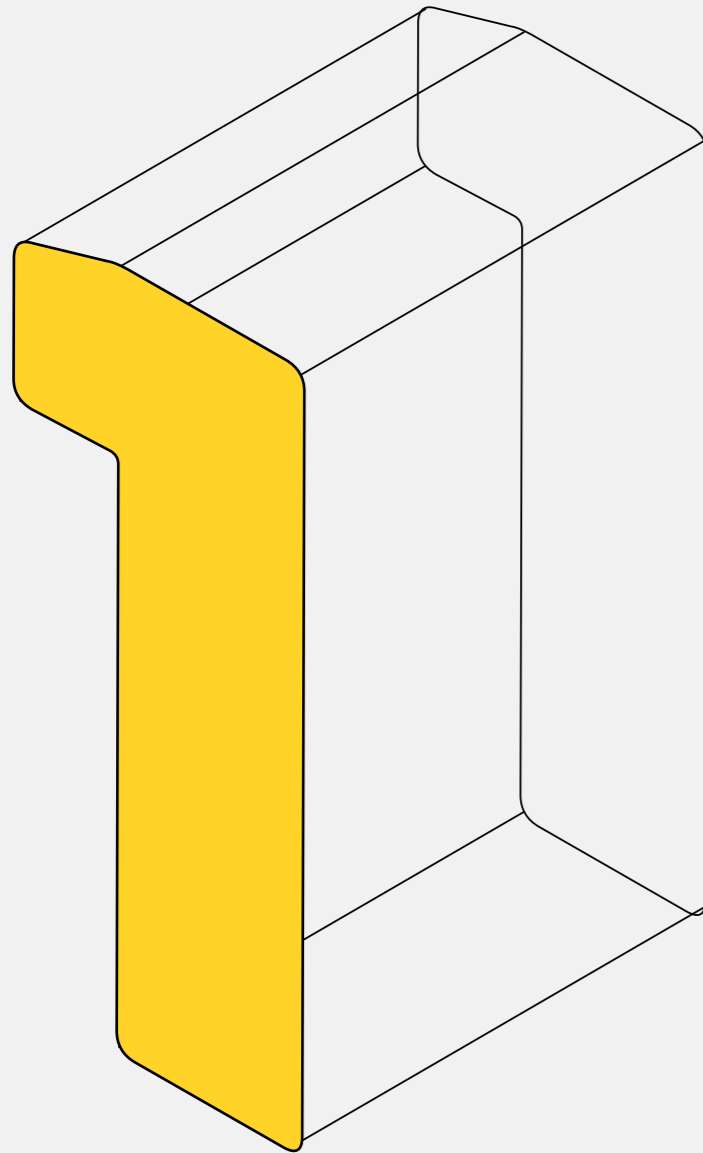

TIP #1

Implementación BIM?

OBJETIVO: Lograr EL MISMO producto que tengo actualmente.

!?





Ro1 1

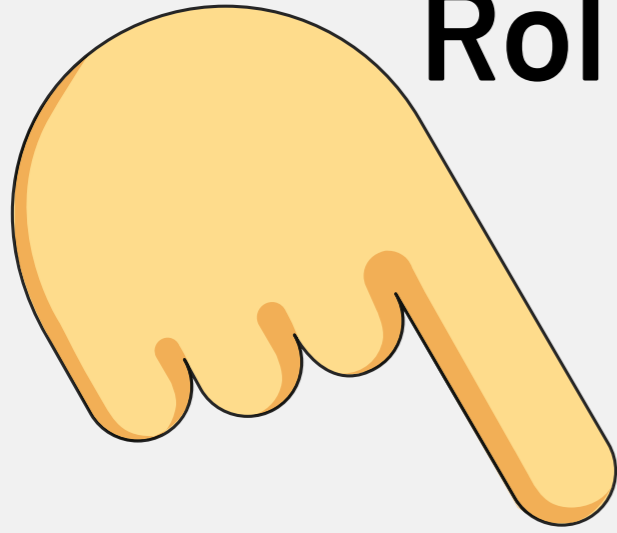

Ro1 2

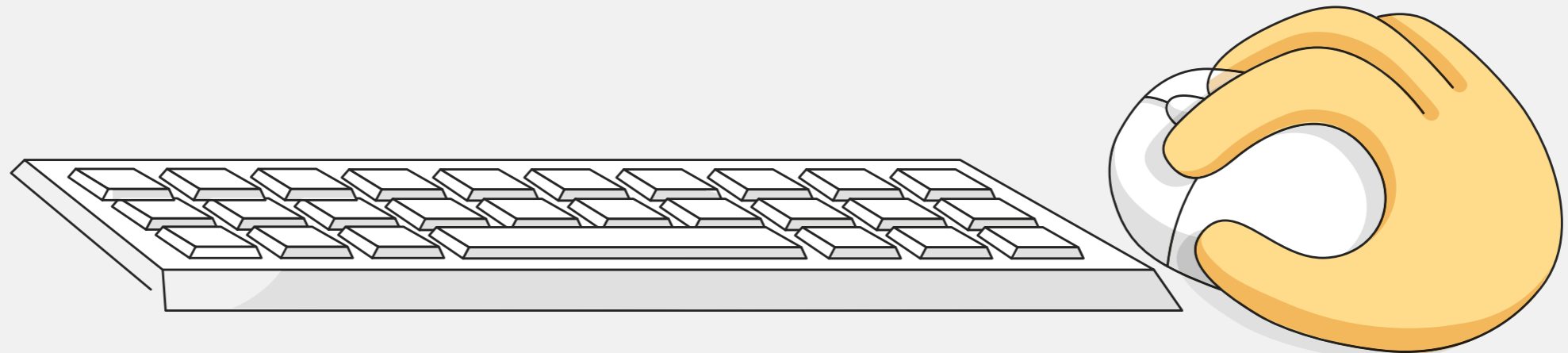



PM

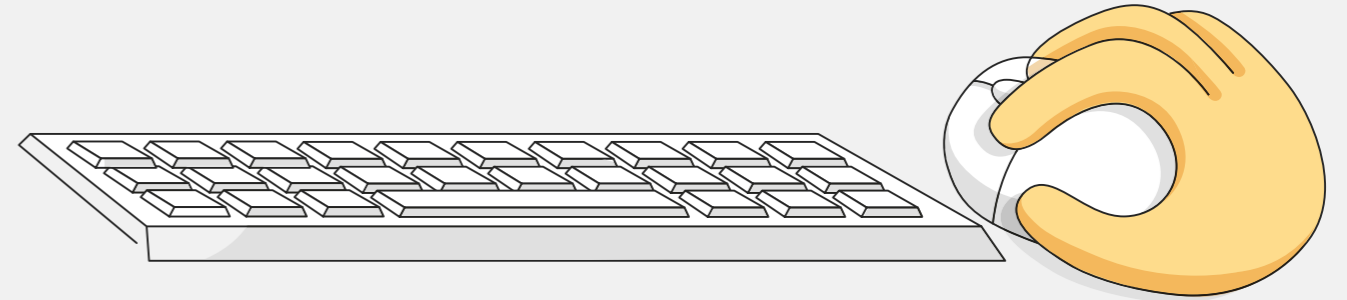

BIM modeler

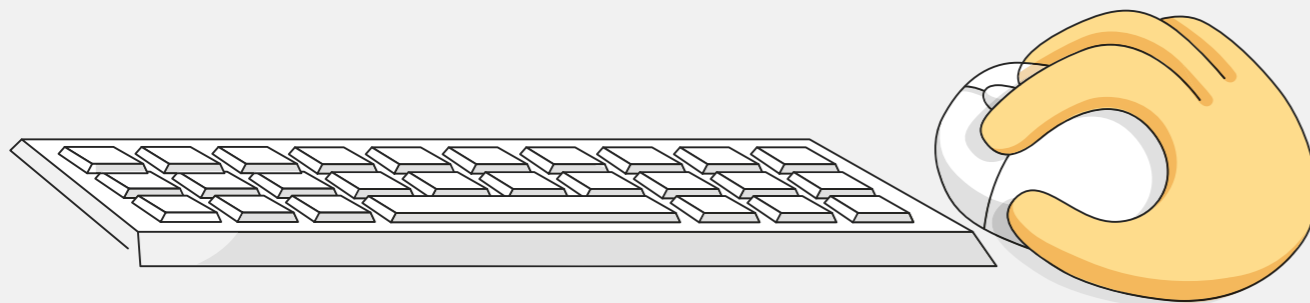

Model Manager

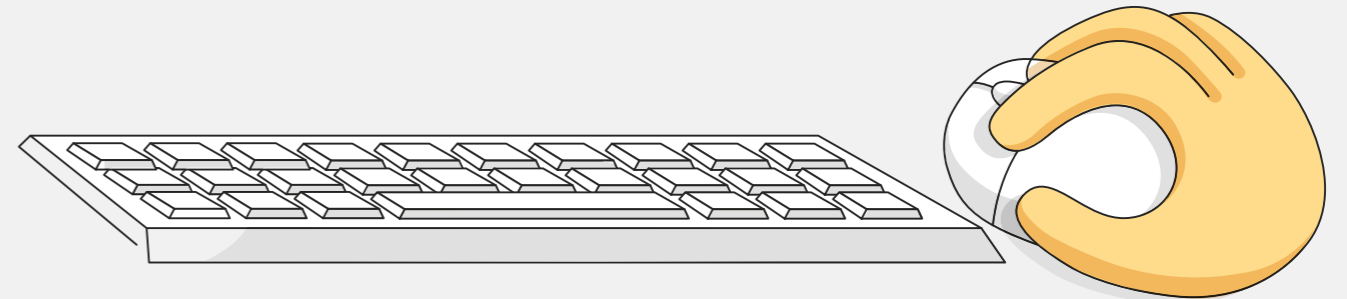

BIM coordinator

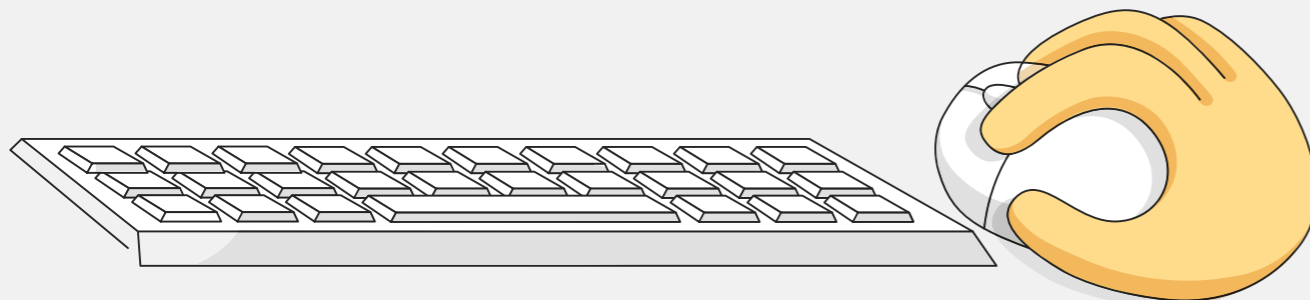

BIM Leader

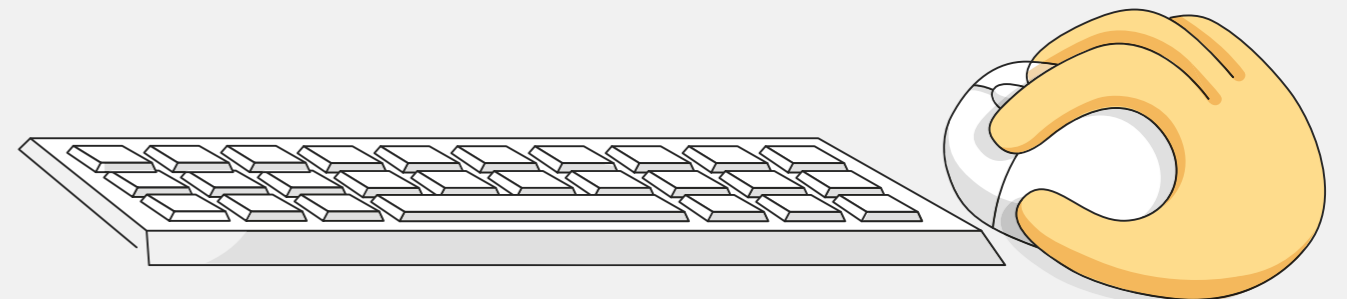

BIM manager



BIM tech & mntce

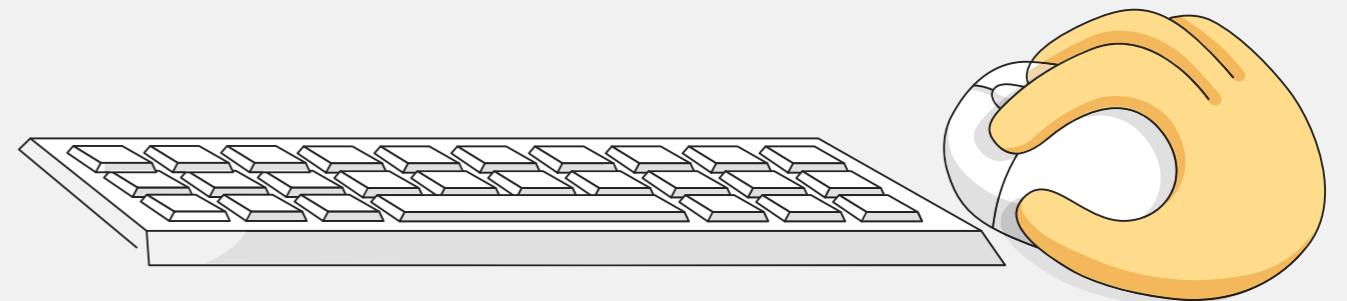

BIM content mng



AGC-Autodesk survey: Labor shortage has industry at a 'tipping point'

The problem is "significant and widespread," and with projects being delayed and construction costs rising, the "time to act is now," AGC and

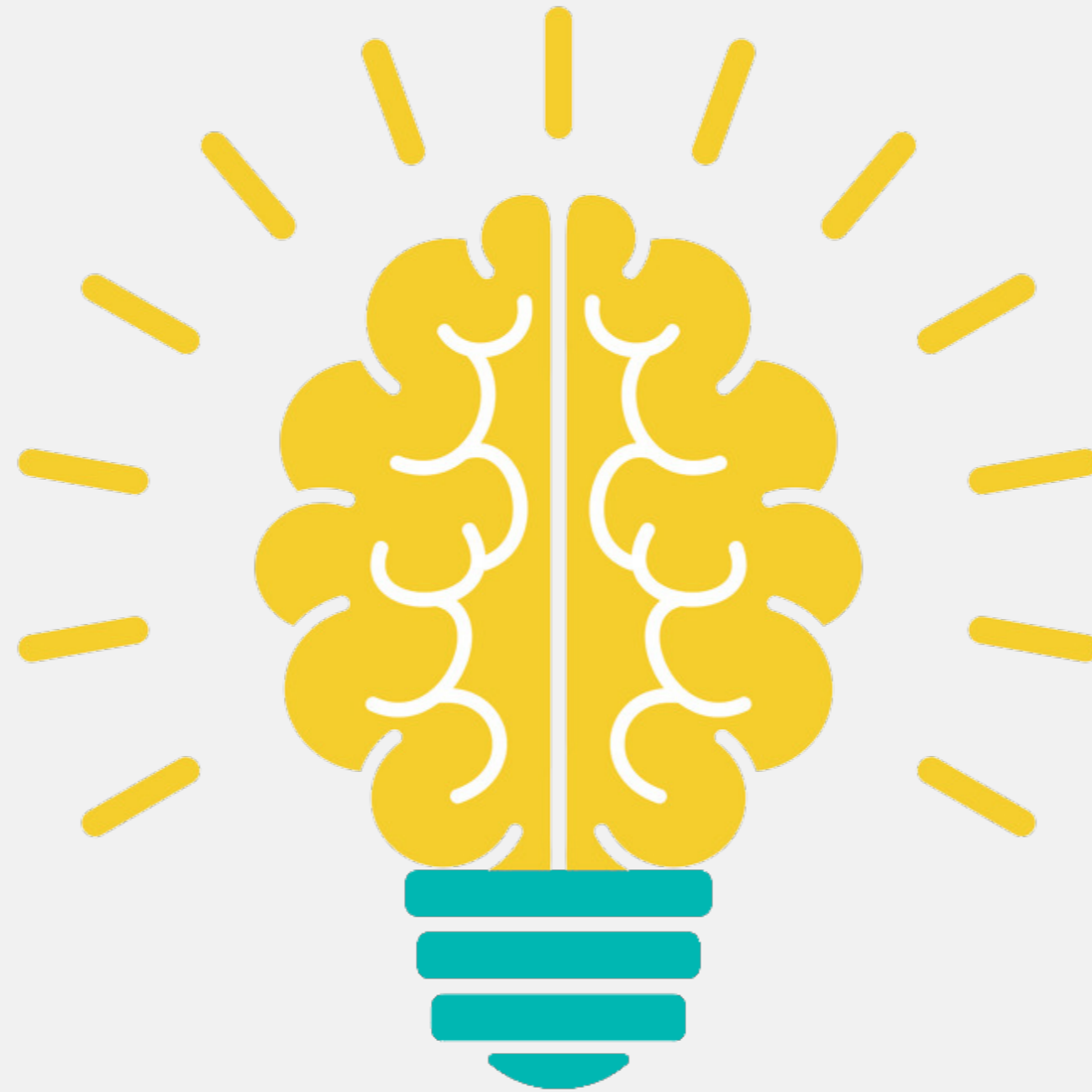

“

45% of tasks people are paid to do each day in AEC industry could be automated with current technology



8 años de carrera

***know-How en
construcción***

generalistas

***min 2 años de
experiencia***



Renombrar Pilares / Vigas

Renumerar Parkings

Planillas de Ventilación

Renumerar Ventanas

Pasar texto a Mayúsculas

Planillas de Iluminación

Renumerar Aberturas

Ajustar Niveles y alturas

Renombrar y Crear Sheets

Estudiar variantes

Nombrar locales por Piso

70 - 80 hs
SEMANALES



DEMOS

TIP #



qué automatizarías?

